

VIISAN®

VS13AI

4K 2-in-1 Document Camera
Built-in AI Noise Reduction Technology

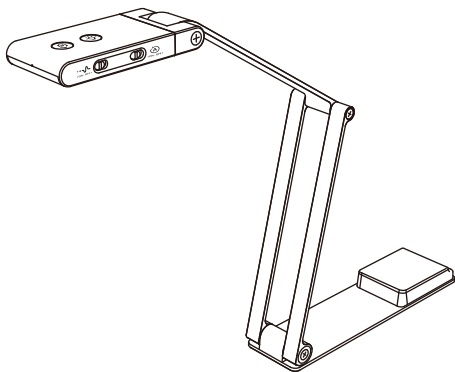

Quick Start Guide

Please read this guide before using the product.

Instructions

Thank you for purchasing the VIISAN product. The VS13AI is a 4K 2-in-1 document camera with an AI Noise Reduction Technology for distance learning and live demonstration. This quick start guide briefly describes the steps to start using this document camera. If you have any technical or service questions about the products, please E-mail our customer service using info@viisan.com then we will provide you with service and support.

Safety & Environmental Information

Federal Communications Commission Statement (Class B)

FC This device complies with Part 15 of the FCC Rules. Operation is subject to the following two conditions: (1) this device may not cause harmful interference, and (2) this device must accept any interference received, including interference that may cause undesired operation. This equipment has been tested and found to comply with the limits for a Class B digital device, pursuant to part 15 of the FCC Rules. These limits are designed to provide reasonable protection against harmful interference in a residential installation. This equipment generates, uses, and can radiate radio frequency energy and, if not installed and used in accordance with the instruction manual, may cause harmful interference to radio communications. However, there is no guarantee that interference will not occur in a particular installation. If this equipment does cause harmful interference to radio or television reception, which can be determined by turning the equipment off and on, the user is encouraged to try to correct the interference by one or more of the following measures:

- Reorient or relocate the receiving antenna.
- Increase the separation between the equipment and receiver.
- Connect the equipment into an outlet on a circuit different from that to which the receiver is connected.
- Consult the dealer or an experienced radio/TV technician for help.

Any changes or modifications not expressly approved by the party responsible for compliance could void the authority to operate the equipment.

CE Class B (EMC)

CE This product is herewith confirmed to comply with the requirements set out in the Council Directives on the Approximation of the laws of the Member States relating to Electromagnetic Compatibility Directive 2014/30/EU.



This symbol on a product or on its packaging indicates that the product must not be disposed of with other household waste. Instead, it is your responsibility to ensure disposal of waste equipment by handing it over to a designated collection point for the recycling of waste electrical and electronic equipment usually at a Local Amenity Site. The proper recycling of your waste equipment at the time of disposal will help to conserve natural resources and ensure that it is recycled in a manner that protects human health and the environment.

Specifications

Image Sensor	13 Megapixel 1/3" CMOS
F/NO (Infinite)	F2.2 ± 5%
G-Sensor	Built-in
AI Noise Reduction Technology	Noise reduction and voice enhancement technology
Output Resolution / FPS	MJPEG: 3840x2880@15fps, 3840x2160@30fps, 3264x2448@30fps, 2592x1944@30fps, 2048x1536@30fps, 1920x1080@60fps, 1600x1200@60fps, 1280x720@60fps, 1024x768@60fps, 960x540@60fps, 640x480@60fps, 640x360@60fps YUY2: 1280x720@10fps, 1024x768@10fps, 960x540@15fps , 640x480@30fps, 640x360@30fps
Digital Zoom	10x by Software
Max. Shooting Area	440 x 330mm (at output 2048x1536)
Video Compression	MJPG, YUY2
Focus	Auto
Image Rotation	0° / 180° / AUTO
Min. Focus distance	10 cm
Support Power Line Frequency	50 / 60 Hz
Microphone Sensitivity	94dB SPL@1KHz Min-29 Tye-26 Max-23 dBFS SNR 64dB
Interface	Micro USB
Powered by	USB 2.0 5V/500mA
Support Operating System	Windows® 11, 10, Windows 8, Windows 7 macOS 10.15 or later
Dimensions	Extended: 397(L) x 51(W) x 351(H) mm Closed: 197 (L) x 51(W) x 20(H) mm
Net Weight	409g

Unpacking

Before using, make sure the following items are included in the package. If anything is missing, contact the retrailer where you purchased the product.

1. VS13AI Document Camera
2. Carry Bag
3. USB Cable
4. Cable Clip x 2
5. Quick Start Guide

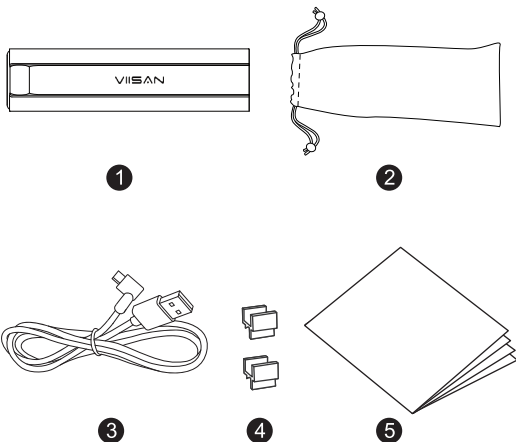

Parts Descriptions

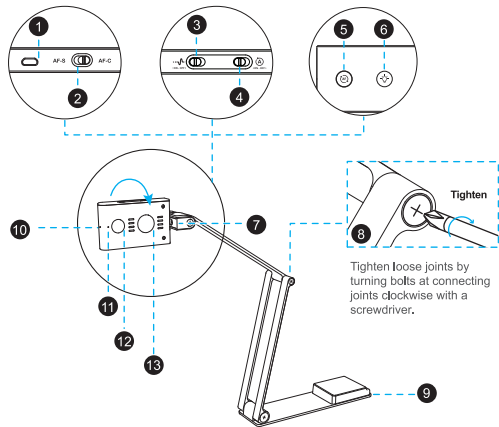

1. USB Port

2. AF-S/AF-C Switch

Switch the slider to change the focus mode to Auto Focus-Single (AF-S) or Auto Focus-Continuous (AF-C)

3. AI Noise Reduction ON/OFF

Switch the slider to enable or disable AI Noise Reduction.

4. Auto Rotate ON/OFF

Switch the slider to turn on / off the G-sensor to enable or disable automatic rotation.

5. Auto Focus/Rotate Button

Press once: Auto Focus

Press and hold: Flip Image 0°/180°

6. LED Touch Button

Press to turn on the LED light (3-level brightness control)

7. Flip Camera Head 0° / 180°

8. Bolts

9. Base Plate

10. LED Indicator

11. Built-in Microphone

12. Camera lens

13. LED Light

Tighten loose joints by turning bolts at connecting joints clockwise with a screwdriver.

Auto Rotate ON/OFF

Scenario 1.

If a user shows a document at the beginning, the G-Sensor will automatically flip the live image when the user rotates the camera head to show the face.

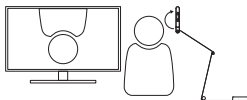
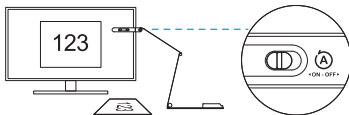

Auto Rotate off

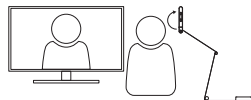

Auto Rotate on

Scenario 2.

If a user shows the face at the beginning, the G-Sensor will automatically flip the live image when the user rotates the camera head to show a document.

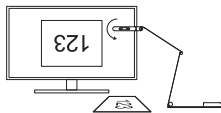
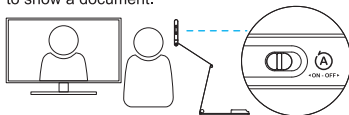

Auto Rotate off

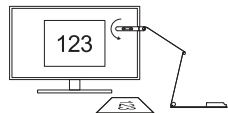

Auto Rotate on

AI Noise Reduction ON/OFF

The VS13AI offers highly effective in maintaining the natural sound of the human voice while reducing noise with high accuracy, creating ideal workspace wherever you are.

AI Noise Reduction off

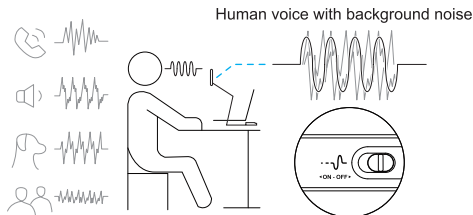

AI Noise Reduction on

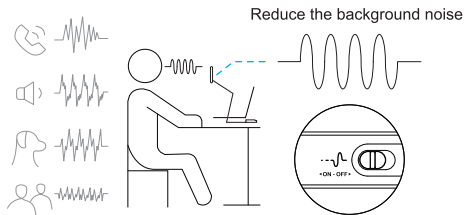

Getting Started 1

1. Lift the camera arm to extend the document camera.

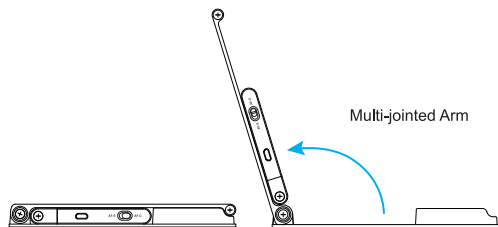

2. Press against the base plate of camera and pull it up then flip the camera head.

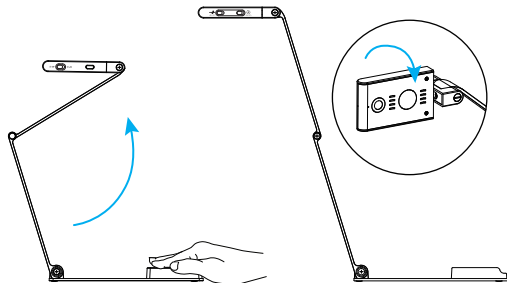

Getting Started 2

- Adjust the arm to change the height and position for capturing materials. Fully extend the camera arm to capture the maximum shooting area to 440 x 330mm (at output 2048x1536).

Camera parallel to the surface
(Minimum shooting distance: 10cm)

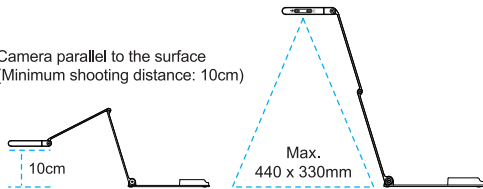

- Plug the supplied USB cable to the camera and connect another end into the computer's USB port (Windows and Mac).
- Attach the cable clips to the camera arm to fix the USB cable.

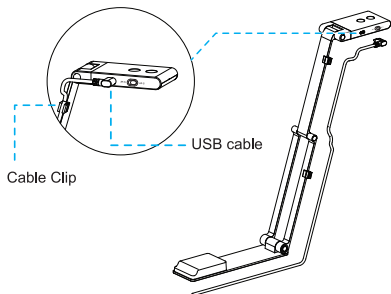

Software Download

Using the compatible software

The VS13AI is a standard UVC camera, you can use it with a variety of software as long as they recognize the video source coming from a UVC camera. For example, you can use it with third-party video conferencing software like Zoom, Microsoft Teams, or Google Meet. However, to get the full functionality of this 4K 2-in-1 document camera, we'd recommend using it with VIISAN VisualCam software. You can download this free software from VIISAN's support center via the below link.

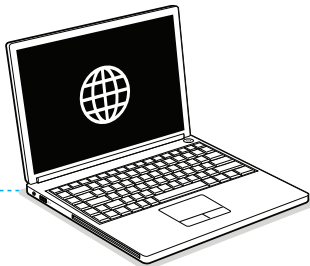

Download the compatible software & user manual at

<https://www.viisan.com/en/download/index.html>



VIISAN VisualCam

Warranty Information

Warranty Card	
Model No.: VS13AI 4K Document Camera	
This product provides limited warranty continues for one (1) year from the date of purchase.	
Name:	Email:
Address:	
Product S/N:	
Reseller Info.:	
Date of purchase:	

VIISAN®

Warranty Exclusions

The following circumstances excluded from warranty coverage:

- Product damage caused by catastrophes, thunder stroke, faulty electric power, and environmental factors,
- Defacing of product labeling (label alterations and falsifying, serial number missing, serial number no longer discernible, serial number invalid). All serial numbers are recorded and tracked for warranty purposes.
- Unauthorized changes of non-parts, modifications or alterations, parts removal in or to the products.
- Damage caused by operator error or operator fails to comply user manual instruction, such as, but not limited to improper storage resulting in product get wet, corrosion, ell off, squeezed or exposed to inadequate temperature/humid environment,
- Accessories or packing material such as boxes, user manual, etc.



VIISAN Technology Co., Ltd.

www.viisan.com

Customer service: info@viisan.com